





**RUSTIC**

11.5302.58



11.5004.58





11.5018.68





11.5085.68



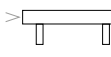
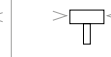

REF.	Diagram		FINISH	
				
11.5018	96	19	58	68
11.5302	64	17	58	68
11.5004	96	19	58	68
11.5085	96	19	58	68



REF.	Diagram				FINISH		
							
11.6362	96	104	-	33	-	58	68
11.2167	96	109	-	29	48	58	68

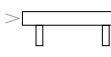

REF.	Diagram			FINISH		
						
11.5096	-	55	20	48	58	68
11.5000	-	35	20	-	58	68
11.5032	-	70	18	-	58	68

RUSTIC



1



2



3



4



5



6





7



8



9

	REF.			FINISH			
1	11.2421	37	30	43	48	58	68
2	11.3758	37	30	43	48	58	68
3	11.0613	31	29	43	48	58	68
4	11.6050	31	30	43	48	58	68
5	11.6000	24	23	43	48	58	68
6	81.9045	26	23	-	-	58	68
7	11.6432	30	26	-	-	58	68
8	11.3570	39/29	34	-	-	58	68
9	11.6152	29	21	-	48	58	68



10



11



12



13





14



15

RUSTIC

	REF.			FINISH		
10	11.6086	32	25	48	58	68
11	11.6300	31	30	48	58	68
12	11.6430	30	24	48	58	68
13	11.6422	32	26	48	58	68
14	81.9006	33	27	48	58	68
15	11.6400	20	23	48	58	68



11.3315.68





11.3316.68



11.3186.68



11.3286.68

	LEFT		RIGHT				FINISH	
Nails	11.3315	⊏	11.3316	180	21	-	58	68
Nails	11.3317	⊟	11.3318	180	21	-	58	68
Dowels	11.7285	⊏	11.3312	180	21	128	58	68
Dowels	11.7284	⊟	11.3313	180	21	128	58	68
Nails	11.3187	○	11.3287	191	27	-	58	68
Nails	11.3188	⊏	11.3288	191	27	-	58	68
Nails	11.3186	⊟	11.3286	191	27	-	58	68



11.7085.68



11.7034.58



11.7424.68



11.1886.68

					FINISH	
Nails	11.7085		140	22	58	68
Nails	11.7086		140	22	58	68
Nails	11.7034		142	15	58	68
Nails	11.7032		142	15	58	68
Nails	11.7424		155	21	58	68
Nails	11.7422		155	21	58	68
Nails	11.1886		110	25	58	68



11.7000.68



11.7002.68

					FINISH	
Nails	11.7000		37	31	58	68
Nails	11.7002		63	34	48	68





1



2



3





4



5



6

		REF.			FINISH			
1	E	11.7952	83	50	43	48	58	68
2	E	11.7942	77	42	43	48	58	68
3	E	11.3242	64	40	43	48	58	68
4	E	11.6978	34	-	43	48	58	68
5	F	11.7916	68	40	43	48	58	68
6	E	11.7980	68	40	43	48	58	68

E = EUROPEAN KEY    F = FRENCH KEY

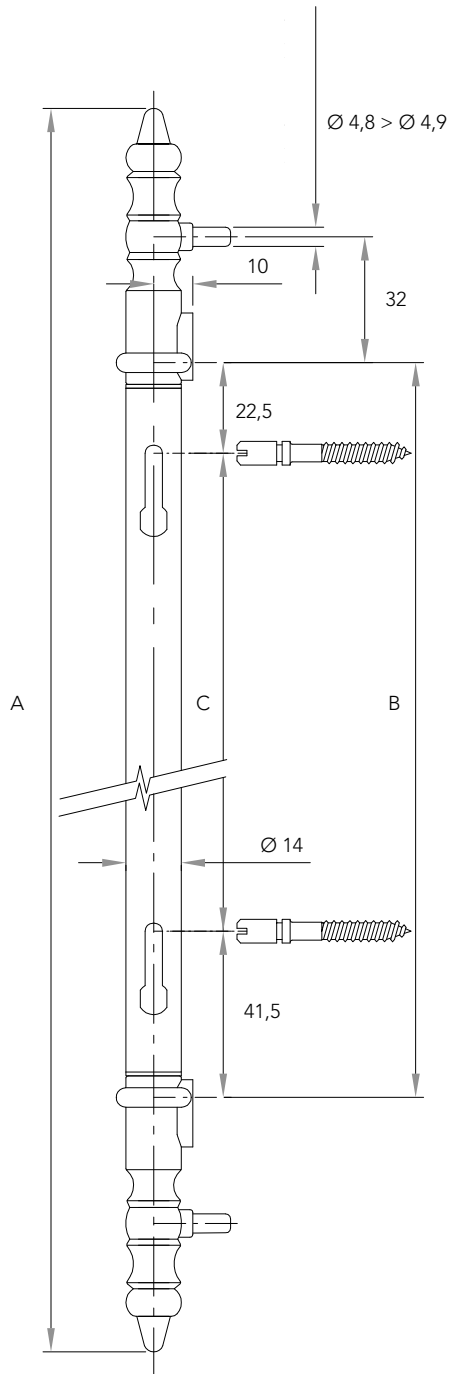

STYLE  
HINGES

## TYPE 25

RUSTIC

### SINGLE

EXAMPLE SIZES REF.	A	B	C
25.0386	386	257	193
25.0450	450	321	257
25.0546	546	417	353

### DOUBLE

longer than 1m - 4 screw holes - 2 tubes with extra fixing piece 25.0003

EXAMPLE SIZES REF.	A	B1	B2	C1	C2
25.1282	1282	577	577	513	513
25.1346	1346	609	609	545	545
25.1538	1538	705	705	641	641

METAKOR PRODUCES ANY DIMENSION - SCREWS INCLUDED

STYLE  
HINGES

# TYPE 54-55

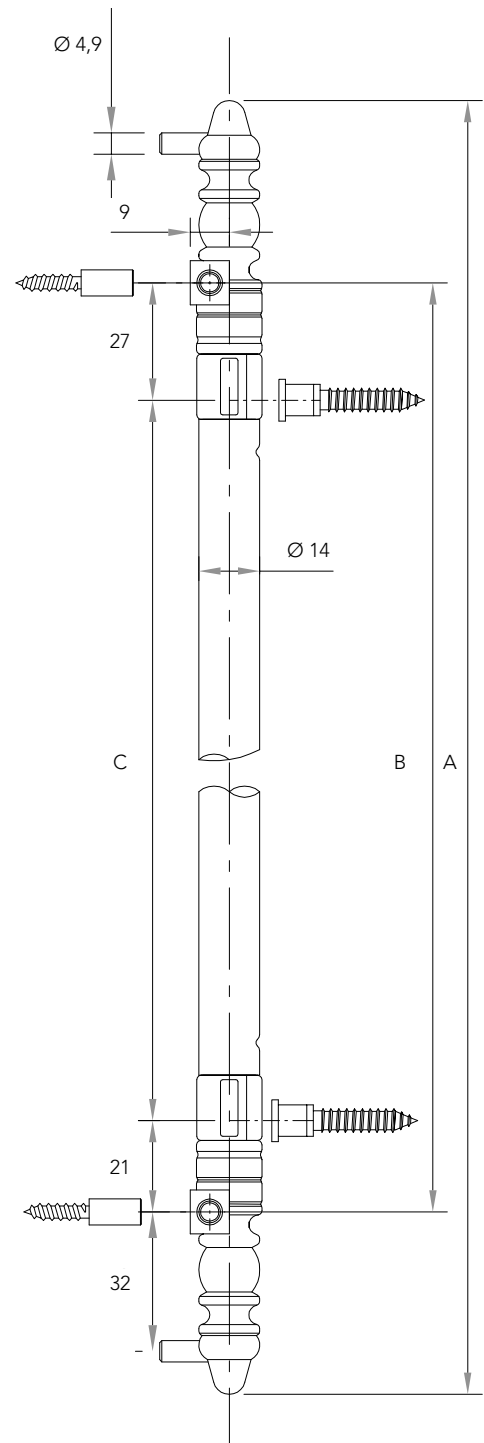

**TYPE 55 IS THE SAME HINGE AS TYPE 54 EQUIPPED WITH AN AUTOMATIC CLOSING SYSTEM AND IS DELIVERED ASSEMBLED**

**SINGLE**

EXAMPLE SIZES REF.	A	B	C
54.0484	484	400	352
54.0516	516	432	384
54.0644	644	560	512

**DOUBLE**

longer than 1m - only type 54 - 2 tubes with extra fixing part 54.0003

EXAMPLE SIZES REF.	A	B1	B2	C1	C2
54.1016	1016	466	466	410	410
54.1140	1140	528	528	472	472
54.1174	1174	545	545	489	489

METAKOR PRODUCES ANY DIMENSION - SCREWS INCLUDED

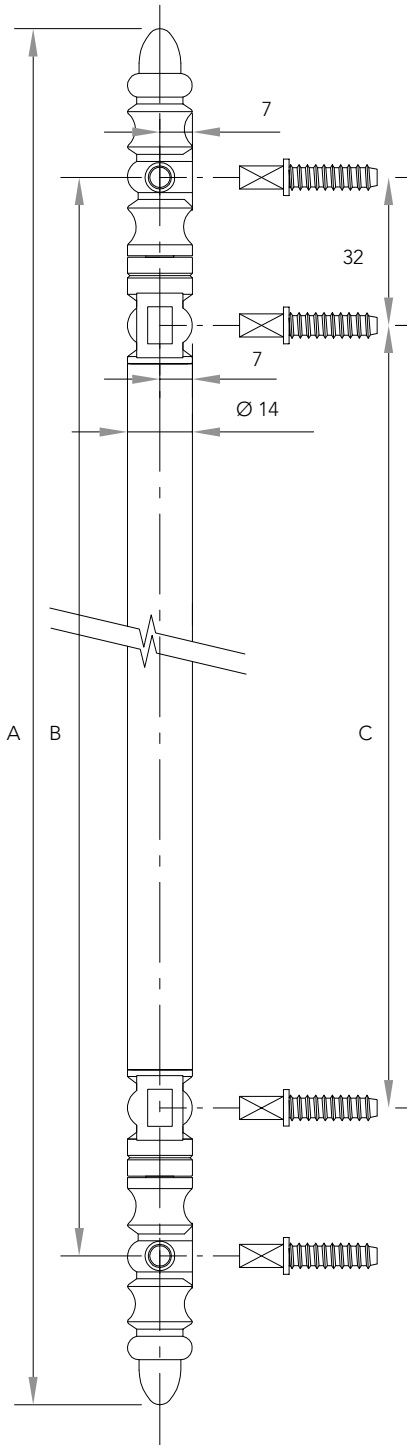

STYLE  
HINGES

# TYPE 57

RUSTIC

DELIVERED ASSEMBLED - NO DOUBLE HINGE AVAILABLE

SINGLE			
EXAMPLE SIZES REF.	A	B	C
57.0494	494	430	366
57.0518	518	454	390
57.0632	632	568	504
57.0908	908	844	780

METAKOR PRODUCES ANY DIMENSION - SCREWS INCLUDED

STANDARD FINISHES AS SPECIFIED PER ARTICLE

---



**07**  
Bright Concrete

---



**08**  
Mat Concrete

---



**24**  
Satin Brushed Gold

---



**28**  
Bright Aged Nickel

---



**29**  
Satin Brushed Nickel

---



**33**  
Bright Aged Red Copper

---



**35**  
Nickel Mat

---

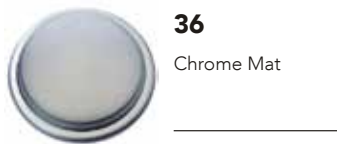

**36**  
Chrome Mat

---



**38**  
Bright Chrome

---



**39**  
Mat Anodised Aluminium

---



**43**  
Mat Dark Bronze

---



**48**  
Bright Dark Bronze

---



**49**  
Bright Brushed Nickel

---



**50**  
Mat Aged Red Copper

---



**53**  
Mat Black Steel

---



**58**  
Pewter

---



**59**  
Mat Old Iron

---



**68**  
Bright Standard Bronze

---



**69**  
Mat Standard Bronze

---



**75**  
Pink Champagne

---



**89**  
Dark Bronze with  
Brushed Red  
Copper Edge

---

LACQUERED FINISHES

---



**12**  
Mat Black RAL  
9005

---



**17**  
Bright Black RAL  
9005

---



**15**  
Bright White RAL  
9003

---



**16**  
Mat White RAL  
9003

---